



Alexander Technological
Educational Institution of
Thessaloniki

A.T.E.I. Of Thessaloniki
Department Of Electronics



www.teithe.gr



Professor Athanasios Hatzigaidas
Head of Department of Electronics



Thessaloniki city





©2006 Google - Imagery ©2006 DigitalGlobe, NASA, Map data ©2005 TeleAtlas - [Terms of Use](#)



Alexander Technological
Educational Institution of
Thessaloniki

A.T.E.I. of Thessaloniki

- ✓ One of the oldest Technological Educational Institutes in our country
- ✓ The A.T.E.I. of Thessaloniki (<http://www.teithe.gr>) is located 15 kms away from the city center, very close to Thessaloniki's suburb of Sindos.
- ✓ The Institution was founded in 1970, it has 1.645 permanent and part-time staff members and approximately 30.000 students
- ✓ 1.415.000 square meters (approximately 400 acres)



The Technological Educational Institute of Thessaloniki (T.E.I.THE.)

The campus includes:

- Classrooms, laboratories, amphitheatres, administration offices and the teaching staff offices.
- Two Halls of Residence and Two Restaurants (there is another Students' Hall and another Restaurant in the center of the city).
- An Infirmary Health Center.
- A Central Library.
- The Publishing Center.
- Conference center & teleconference facilities



Physical Education

Modules for Erasmus Students
Greek Language Teaching Course
Specific Courses in English language





Alexander Technological Educational Institution of Thessaloniki

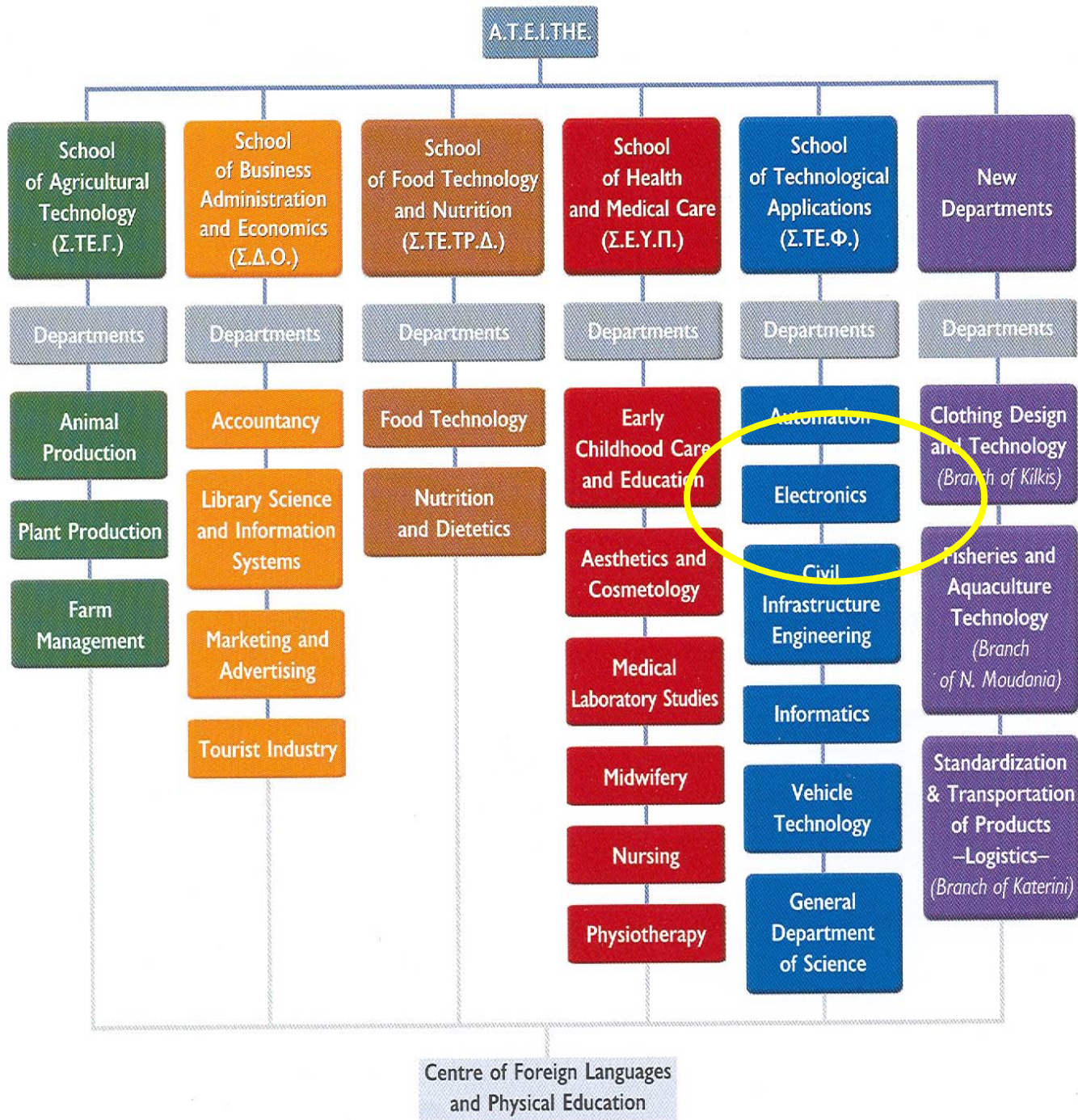



Alexander Technological
Educational Institution of
Thessaloniki

School of Technological Applications



**DEPARTMENT
OF
AUTOMATION**



**DEPARTMENT
OF CIVIL
INFRASTRUCTURE
ENGINEERING**



**DEPARTMENT
OF
ELECTRONICS**



**DEPARTMENT
OF
INFORMATICS**



**DEPARTMENT
OF
VEHICLE
TECHNOLOGY**

Main Menu

- [History](#)
- [Administration](#)
- [Faculty & Staff](#)
- [Staff C.V.](#)
- [Access](#)
- [Academics](#)
- [Research](#)
- [European Programs](#)
- [Photos](#)



The Department of
Electronics



The Atrium



The Amphitheatre



One of the six lecture
rooms/classrooms



Laboratory of Digital Circuits



The 'Euclid' building

Research

- Communications Systems
- RF MEMs switches
- Antenna analysis and design
- Wireless communication systems
- Networks systems through Zigbee
- Optical communication systems
- Electromagnetic radiation measurements and effects
- High Definition Digital Terrestrial TV

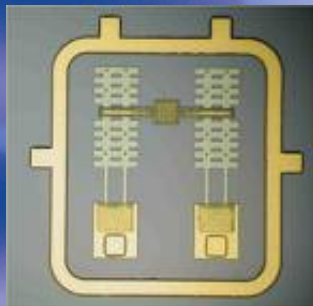

Renewable Energy
Applications and
Control (wind, PV,
biomass)
fuel cells
Power Quality in
Transmission and
Distribution Systems

Research

Information Systems / Artificial Intelligence
 Semantic web-topic maps

E-learning-Intelligent systems

Reconfigurable Computing using FPGAs

Digital Image and Signal Processing:
 Biomedical applications
 (2D-3D Medical Imaging)
 Bio-signal processing

Neural net models for simulating CNS
 structure/function

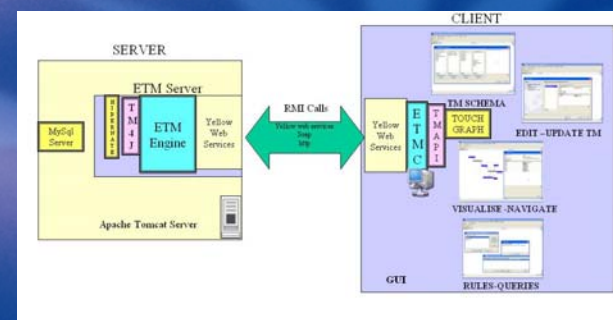
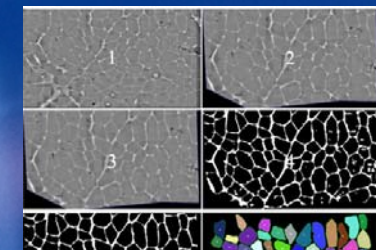
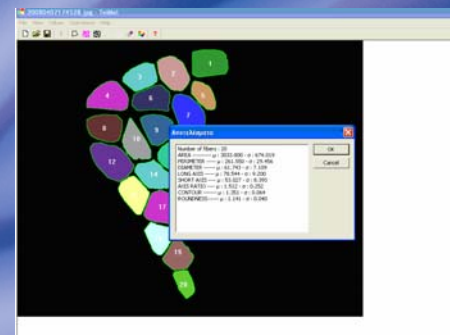
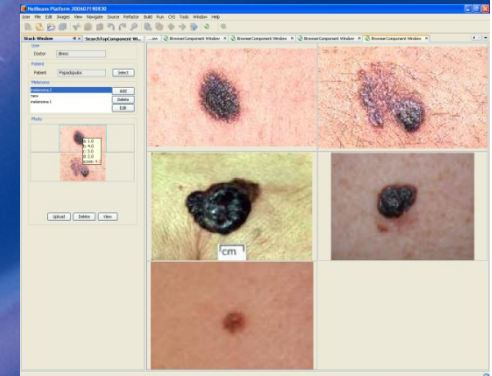
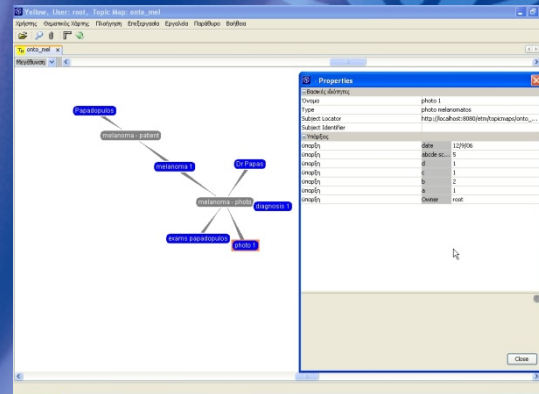

International Collaborations

Brunel University London

MSc in Wireless Communication Systems

Research projects on HDTV and MEMS, PhD

Ecole Nationale Supérieure
des Télécommunications, Paris

Research projects on HDTV measurements,

Publications, PhD students

Lifelong Learning Programme (LLP) / Erasmus

- The new Life Long Learning Programme (LLP), supports learning opportunities from childhood to old age in every single life situation.
- It has a budget of €7000 million for the period 2007 - 2013, and is the successor to the current Socrates, Leonardo da Vinci and eLearning programmes.
- Grants and subsidies will be awarded to projects and activities that foster interchange, promote bilateral and multilateral partnerships, foster trans-national mobility of individuals and promote quality in education and training systems throughout Europe.
- <http://www.socrates.teithe.gr>





Alexander Technological
Educational Institution of
Thessaloniki

Coordinator of the project
ATEI of Thessaloniki

ERASMUS MUNDUS

External Cooperation Window for
Georgia, Armenia and Azerbaijan (Lot 5)



Funded by the EC-EACEA



The Erasmus Mundus ECW project

External Cooperation Window for Georgia, Armenia and Azerbaijan

Lot 5

Coordinator of the project
ATEI of Thessaloniki



Alexander Technological
Educational Institution of
Thessaloniki



Members of the Partnership

INSTITUTION

1. Alexander TEI of Thessaloniki GREECE
www.teithe.gr/

2. University of Angers FRANCE
www.univ-angers.fr

3. Rezekne's Augstskola REZEKNE,
LATVIA
www.ru.lv/

4. University of Rousse "Angel Kanchev" BULGARIA
www.ru.acad.bg

5. University of Tuscia VITERBO, ITALY
www.unitus.it/

6. Polytechnic Institute of Viana do Castelo PORTUGAL
www.ipvc.pt/

7. HAS Den Bosch Univ. of Applied Sciences
THE NETHERLANDS www.hasdenbosch.nl/

8. Ivane Javakhishvili Tbilisi State University GEORGIA
www.tsu.ge/international

9. Shota Rustaveli State University GEORGIA
www.bsu.edu.ge/

10. Iakob Gogebashvili Telavi State University GEORGIA
www.tesau.edu.ge/

11. Gavar State University ARMENIA
www.gsu.am/

12. Gyumri State Pedagogical Institute ARMENIA
www.gspi.am/

13. Armenian State University of Economics
www.asue.am/

14. Yerevan State University
www.y-su.am/

15. Armenian State Agrarian University
www.armagrar-uni.am/eng/eng-index.htm

16. Azerbaijan Tourism Institute
www.tourism.edu.az/

17. Ganja State University

18. Khazar University
www.khazar.org/



Erasmus Mundus
External Cooperation Window



Open to
the World



ERASMUS MUNDUS

External Cooperation Window for
Georgia, Armenia and Azerbaijan (Lot 5)

 Funded by the EC-EACEA

Number of Individual Mobility Activities Foreseen(academic year 2008/9)

Erasmus Mundus
External Cooperation Window



**Open to
the World**



A. Per type of mobility

Type of Mobility	Europeans	Third-Country nationals				TOTAL
	Target Group 1	Ctry code	Target Group 1	Target Group 2	Target Group 3	
Undergraduates	2	GE	21	Not applicable	1	50
	2	AZ	9		1	
	3	AM	10		1	
Masters	1	GE	9	5	2	34
	-	AZ	4	2	2	
	1	AM	4	2	2	
Doctorates	1	GE	5	5	2	28
	1	AZ	4	2	1	
	-	AM	3	2	2	
Post-doctorates	-	GE	4	1	-	14
		AZ	3	1	1	
		AM	3	1	-	
Teaching staff	1	GE	3	Not applicable	Not applicable	14
	1	AZ	3			
	1	AM	5			
TOTAL	14		90	21	15	140

ERASMUS MUNDUS

External Cooperation Window for
Georgia, Armenia and Azerbaijan (Lot 5)



Funded by the EC-EACEA

Number of Individual Mobility Activities Foreseen(academic year 2008/9)

Erasmus Mundus
External Cooperation Window



Open to
the World



B. Per third-country concerned by the geographical lot

Third-Country name	Undergraduates	Masters	Doctorates	Post-doctorates	Teaching staff	TOTAL
Georgia	22	16	12	5	3	58
Azerbaijan	10	8	7	5	3	33
Armenia	11	8	7	4	5	35
TOTAL	43	32	26	14	11	126

ERASMUS MUNDUS

External Cooperation Window for
Georgia, Armenia and Azerbaijan (Lot 5)



Funded by the EC-EACEA

Financial Conditions

Monthly amount for subsistence allowances (2008/9)

Erasmus Mundus
External Cooperation Window



**Open to
the World**



Mobility type	Target	Nationality	Amount	Duration	
				EU	SC
Undergraduate	Group 1	European students	1 000 EUR	6 months	10 months
		South Caucasian nationals	1 000 EUR		
	Group 3	South Caucasian nationals	1 000 EUR		
Master	Group 1	European students	1 000 EUR	6 months	20 months
		South Caucasian nationals	1 000 EUR		
	Groups 2 & 3	South Caucasian nationals	1 000 EUR		
Doctorate	All Groups	European students & South Caucasian nationals	1 500 EUR	6 months	24X10 months 1X20 months 1X32 months
Post-doctorate	All Groups	European students & South Caucasian nationals	1 800 EUR	---	6 months
Academic staff	Group 1	European & South Caucasian nationals	2 500 EUR	1 month	1 month

ERASMUS MUNDUS

External Cooperation Window for
Georgia, Armenia and Azerbaijan (Lot 5)



Funded by the EC-EACEA



<http://erasmusmundus5.teithe.gr>

Erasmus Mundus
External Cooperation Window



Open to
the World



Introduction - Microsoft Internet Explorer

Αρχείο Επεξεργασία Προβολή Αγαπημένα Εργαλεία Βοήθεια

Πίσω Αναζήτηση Αγαπημένα

http://www.erasmusmundus5.gr/ Μετάβαση Συνδέσεις

ERASMUS MUNDUS

External Cooperation Window for
Georgia, Armenia and Azerbaijan (Lot 5)

Funded by the EC-EACEA

[Members](#) | [Location of the Partners](#) | [Associates](#)

GENERAL INFORMATION

- Introduction
- Objectives
- Frequently Asked Questions
- Announcements
- Scientific News
- Social News
- Guestbook
- Links
- Photo Gallery
- Contacts

Introduction

This project is addressed to Lot 5 that consists of Armenia, Georgia and Azerbaijan, while the EU partners and associates are from Greece, Portugal, Italy, France, The Netherlands, Latvia and Bulgaria. The project targets to all groups (1, 2 & 3) and it provides opportunities of mobility to students (undergraduate & master), researchers (doctorate & post-doctorate) and academic staff. Priority is given on an impartial distribution of available positions to students with special needs and with socio-economical problems (without parents, divorced or ill parents, very low income, etc.), through a transparent selection process making use of a weight coefficient according to the category each candidate belongs to.

The main activities of the project for the academic year 2008/9 are:

- Three consortium meetings with the participation of representatives from all the partner institutions. The meetings will take place in Italy, in France and in the Netherlands
- Training programs for S. Caucasian Master students in Greece and in the partner EU countries leading to Master's Degrees
- Preparation and publication of a DVD on the project in English

Search
search...

Erasmus Mundus External Cooperation Window for Belarus, Moldova and Ukraine (Lot 6)



Universidad de Deusto
Deustuko Unibertsitatea



Erasmus Mundus External Cooperation Window for Belarus, Moldova and Ukraine (Lot 6)

**General
Information**

**Mobility
Grants**

Members



Erasmus Mundus External Cooperation Window for Belarus, Moldova and Ukraine (Lot 6)

Mobility Grants per month:

Type of Mobility	Belarus, Moldova, Ukraine	EU – Other Europeans
Undergraduates	1.000 €	1000 €
Masters	1.000 €	1000 €
Doctorate	1.500 €	
Post-Doctoral	1.800 €	
Academic staff	2.500 €	

Maximum duration of mobility periods in months:

Type of Mobility	Belarus, Moldova, Ukraine	EU – Other Europeans
Undergraduates	10	6
Masters	16	6
Doctorate	20	6
Post-Doctoral	6	6
Academic staff	1	1

Insurance: 75 €/month

Erasmus Mundus External Cooperation Window for Belarus, Moldova and Ukraine (Lot 6)

<http://www.relint.deusto.es/ECWLot6/index.htm>

Erasmus Mundus External Cooperation Window for Belarus, Moldova and Ukraine (Lot 6) - Microsoft Internet Explorer

Αρχείο Επεξεργασία Προβολή Αγαπημένα Εργαλεία Βοήθεια

Πίσω Αναζήτηση Αγαπημένα

http://www.relint.deusto.es/ECWLot6/members.htm Μετάβαση Συνδέσεις

Universidad de Deusto
Deusto

Home Erasmus Mundus External Cooperation Window for Belarus, Moldova and Ukraine (Lot 6)

Erasmus Mundus External Cooperation Window for Belarus, Moldova and Ukraine (Lot 6)

Erasmus Mundus External Cooperation Window for Belarus, Moldova and Ukraine (Lot 6)

Co-ordinating institution

Universidad de Deusto
Avenida de las Universidades, 24
48007 Bilbao
Spain
Tel: 34.94.413 94 08 // 9095
Fax: 34.94.413 90 69
E-mail: EMECWLot6@relint.deusto.es

General Information
Members
Co-ordinating institution
Partner Institutions
Associate Organisations
Mobility Grants

Erasmus Mundus External Cooperation Window for Belarus, Moldova and Ukraine (Lot 6) © 2007, All rights reserved

Tempus: Modernising higher education



Tempus IV Second Call for Proposals EAC/01/2009

- The Second Call for Proposals (EAC/01/2009) under Tempus IV invites the submission of cooperative projects under two actions types, Joint Projects and Structural Measures, from partnerships comprised of higher education institutions, enterprises, ministries, NGOs, associations etc., from the EU and the Partner Countries.
- The indicative total budget for this Call amounts to approximately €53 million in total, and the individual projects grants from €0.5 to €1.5 million.
- The deadline for the electronic submission of proposals is Tuesday, 28 April 2009.

The Tempus programme - Regions and Countries

A list of [selected projects per region](#) after each call for proposal is available for consultation

Partner Countries

By clicking on the countries below, you will find information about their higher education sector, National Tempus Offices and current Tempus projects.

Western Balkan countries covered by the Instrument for Pre accession Assistance

- [Albania](#)
- [Bosnia and Herzegovina](#)
- [Croatia](#)
- [The former Yugoslav Republic of Macedonia](#)
- [Montenegro](#)
- [Kosovo](#)
- [Serbia](#)

Countries of Eastern Europe, North Africa and the Middle East covered by the European Neighbourhood and Partnership Instrument

- [Algeria](#)
- [Armenia](#)
- [Azerbaijan](#)
- [Belarus](#)
- [Egypt](#)
- [Georgia](#)
- [Israel](#)
- [Jordan](#)
- [Lebanon](#)
- [Moldova](#)
- [Morocco](#)
- [The Occupied Palestinian Territory](#)
- [The Russian Federation](#)
- [Syria](#)
- [Tunisia](#)
- [Ukraine](#)

The Tempus programme - Partner country : Belarus

1. [National Tempus Office](#)
2. [Review of higher education in Belarus - The Republic of Belarus – National system of Education](#)
Higher education reviews are prepared by National Tempus Offices in the partner countries. The European Commission takes no responsibility for the content of these reviews
3. [Description of projects funded under Tempus I and II in Belarus](#)
4. [Description of projects funded under Tempus III in Belarus](#)
5. [Description of projects funded in 2008 under Tempus IV in Belarus](#)
6. [Brief summary of Tempus impact study in Belarus](#)

National Tempus Office

Mr. Nikolai Listopad
National Tempus Office
Central Information and Analytical Center of the Ministry of Education of Belarus
59, Zakharova Str.,
220088 Minsk
Tel: +375 172 941594
Fax: +375 172 100099
e-mail: listopad@unibel.by

http://ec.europa.eu/education/programmes/tempus/countries/belarus_en.html



Alexander Technological
Educational Institution of
Thessaloniki

www.el.teithe.gr

